



Extruidos de Aluminio







**Barandas**

Tel/Fax: (54-11) 2205-3208 (líneas rotativas)  
info@aluminioamericano.com.ar  
asistencia@aluminioamericano.com.ar  
www.aluminioamericano.com.ar

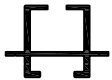
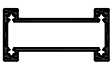





2024+

## Indice de perfiles

Código	Forma	Denominación	Peso Kg/m
BA-041		Portavidrio	0,446
BA-042		Soporte	1,060
BA-043		Parante	0,858
BA-046		Pasamano	0,497
BA-047		Pasamanos recto	0,896
BA-048		Tapa inferior	0,491

Sujeto a modificaciones sin previo aviso.

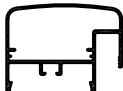
## Baranda

Código	Forma	Denominación	Peso Kg/m
BA-420		Base baranda	7,275
BA-421		Tapa baranda	0,278
BA-502		Columna	0,833
BA-503		Tapa inferior pasamanos	0,266
BA-513		Pasamanos recto	1,363
BA-514		Guía inferior	0,436

Sujeto a modificaciones sin previo aviso.

## Baranda

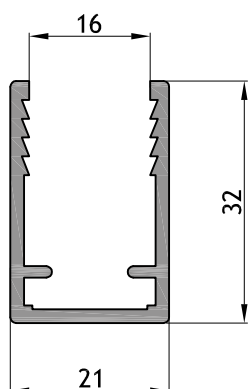

**BA - 041**  
**Portavidrio**  
 Peso: 0,446 kg/m  
 Largo: 6150 mm

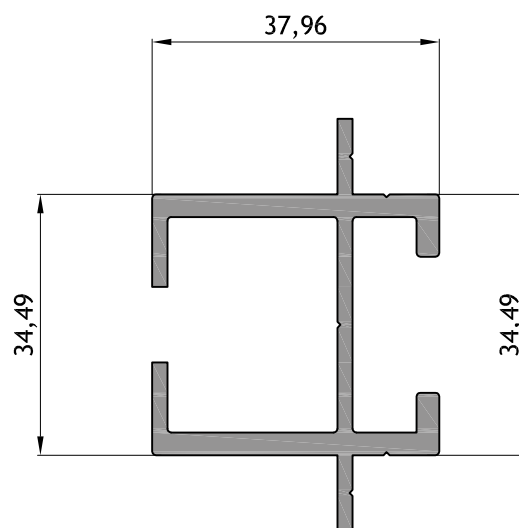

**BA - 042**  
**Soporte**  
 Peso: 1,060 kg/m  
 Largo: 6150 mm

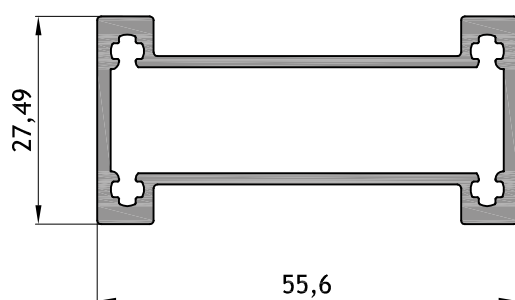

**BA - 043**  
**Parante**  
 Peso: 0,858 kg/m  
 Largo: 6150 mm

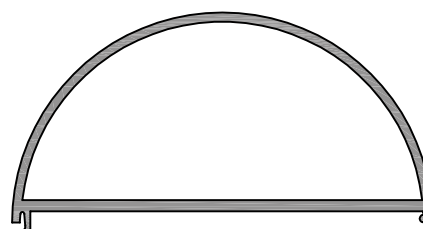

**BA - 046**  
**Pasamano**  
 Peso: 0,497 kg/m  
 Largo: 6150 mm

## Baranda

---

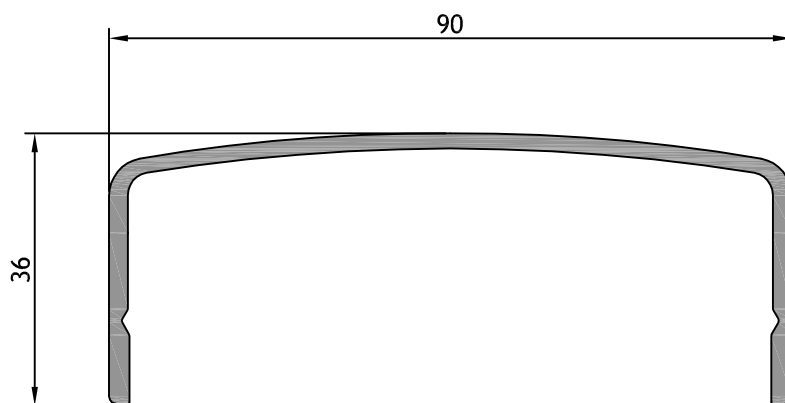

**BA - 047**  
**Pasamanos recto**  
Peso: 0,896 kg/m  
Largo: 6150 mm



**BA - 048**  
**Tapa inferior**  
Peso: 0,491 kg/m  
Largo: 6150 mm

## Baranda

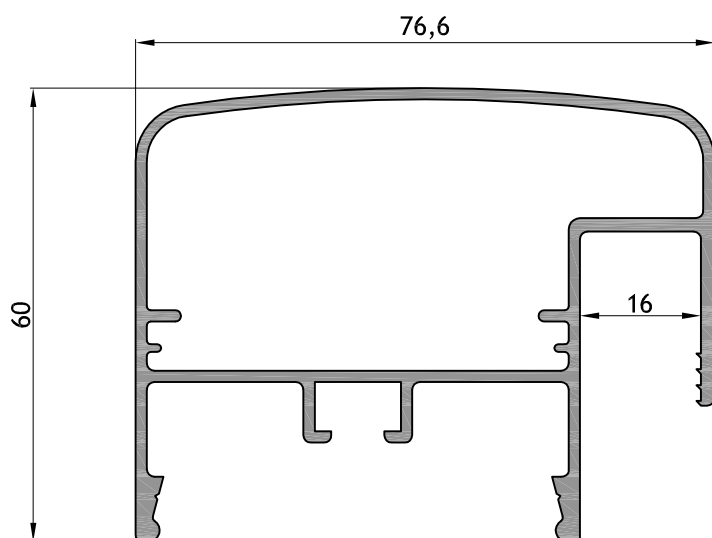

**BA - 513**  
**Pasamanos recto**  
 Peso: 1,363 kg/m  
 Largo: 6150 mm

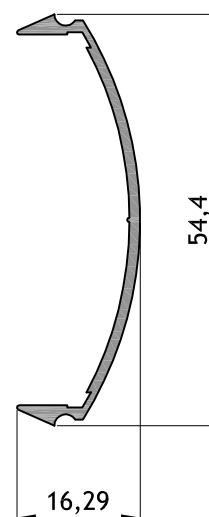

**BA - 503**  
**Tapa inferior pasamanos**  
 Peso: 0,266 kg/m  
 Largo: 6150 mm

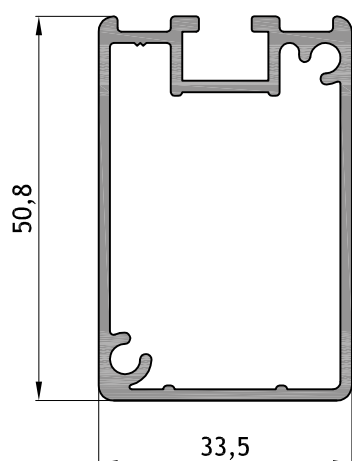

**BA - 502**  
**Columna**  
 Peso: 0,833 kg/m  
 Largo: 6150 mm

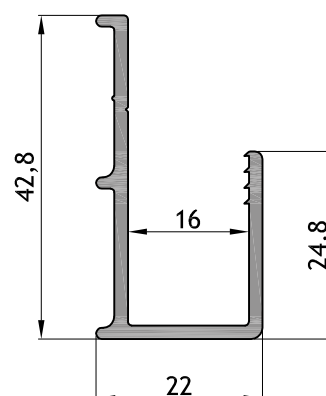

**BA - 514**  
**Guía inferior**  
 Peso: 0,436 kg/m  
 Largo: 6150 mm

## Baranda

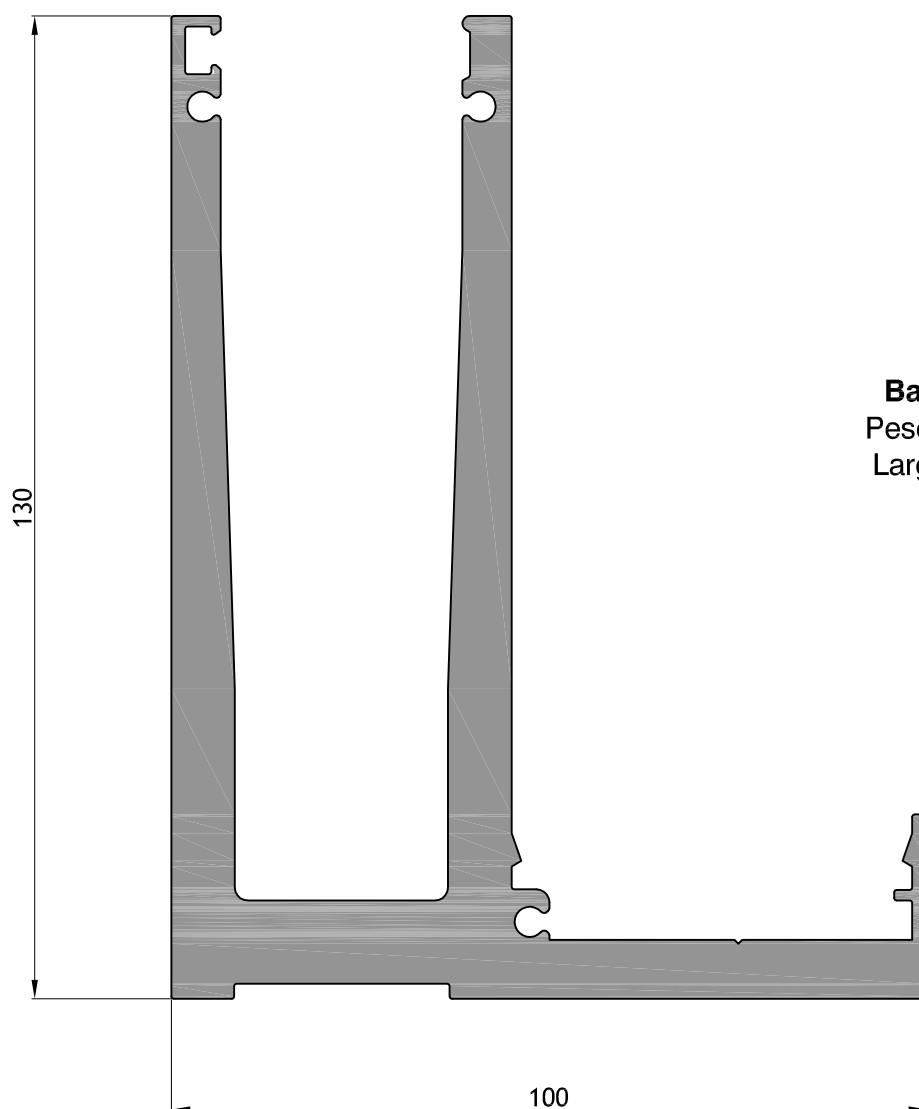

**BA - 420**  
**Base baranda**  
Peso: 7,275 kg/m  
Largo: 3000 mm

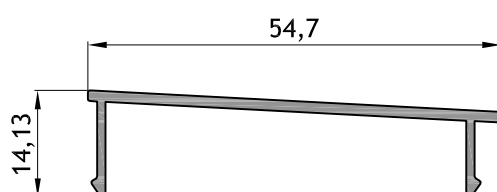

**BA - 421**  
**Tapa baranda**  
Peso: 0,278 kg/m  
Largo: 6000 mm